

## TATTLETALE<sup>®</sup> - Annunciators and Magnetic Switches Models 518PH/518APH/518E Installation and Operations Manual

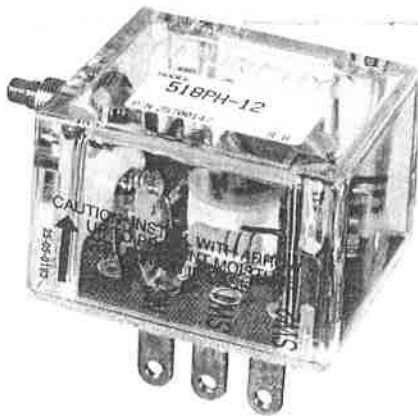

Tattletale annunciators and magnetic switches are the nerve centers that translate Switchgag contact operations into decisions and operate the alarm or shutdown device. They are the electrical load carrying devices for the alarm or shutdown device. Tattletale annunciators indicate which monitored function failed leading to the alarm or shutdown whereas magnetic switches do not. Magnetic switches operate basically as a latching relay.

### Application

Magnetic switches and Tattletale annunciators are available for use with engines or electric motors. Various circuits, time delays and contact configurations are available to match the power source and mode of operation required for alarm only, alarm before shutdown or shutdown only.

For distributor ignition engines, the magnetic switch opens the distributor coil circuit to cause shutdown. For magneto or CD ignitions the magnetic switch grounds the ignition output. Some models can also trip fuel valves instead of or in addition to grounding the ignition. Diesel engines are shut down by closing off either the fuel or air supply. Magnetic switches and Tattletale annunciators can make or break circuits for these engines.

For electric motor application, various magnetic switches are available to operate the motor starter, holding coil directly or in conjunction with appropriate Murphy Transformer-Relay assembly.

### Installation

Please read the following information before installing. A visual inspection of this product for damage during shipping is recommended before mounting. It is your responsibility to have a qualified person install this unit.

### **WARNING! BEFORE BEGINNING INSTALLATION OF THIS MURPHY PRODUCT**

- ✓ **Read and follow all Installation Instructions.**
- ✓ **Disconnect all electrical power to the machine.**
- ✓ **Make sure the machine cannot operate during installation.**
- ✓ **Follow all safety warnings of the machine manufacturer.**

**CAUTION:** Certain dangers to human safety and to equipment may occur if some equipment is stopped without pre-warning. It is recommended that monitored functions be limited to alarm only or to alarm before shutdown.

# Dimensions and Installation

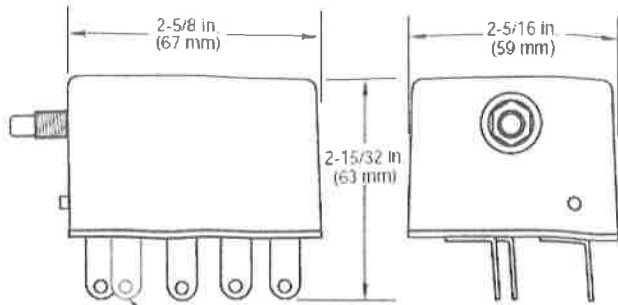

## Mounting Holes

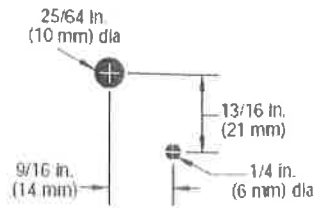

## Installation

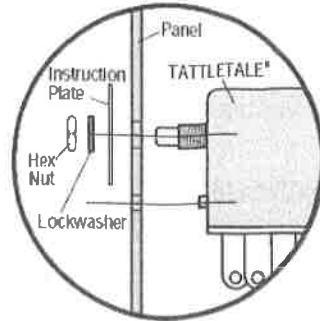

# Typical Wiring Diagrams

Figure 1 shows a jumper installed between "SW1 and SW2." SWICHGAGE® instruments are normally open. This is not a Closed Loop™ circuit.

**Figure 1**

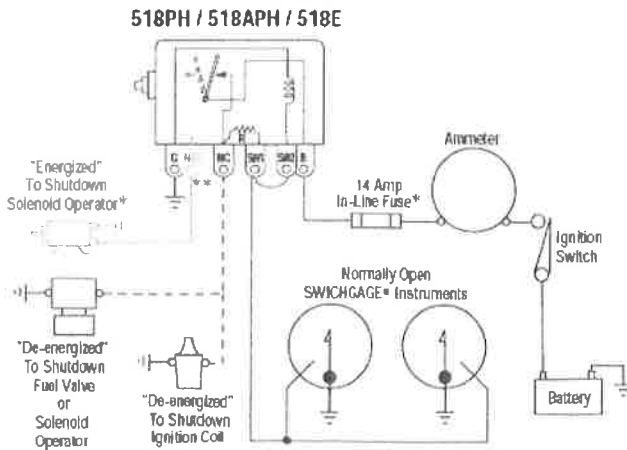

\* In-Line Fuse should be removed on "energized" to shutdown configurations.  
 \*\* Applies to 518APH model.

Figure 2 shows a Closed Loop™ circuit with normally open Murphy SWICHGAGE® instruments and Normally Closed switches (alignment and "V" belt switches, etc.).

**Figure 2**

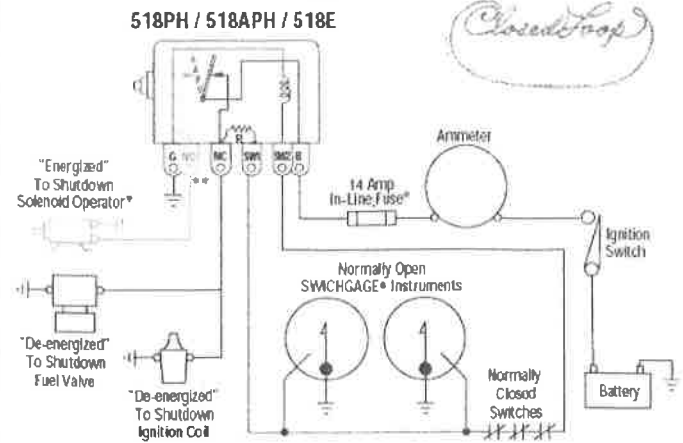

\* In-Line Fuse should be removed on "energized" to shutdown configurations.  
 \*\* Applies to 518APH model.

## Troubleshooting

**Push button will not remain in the depressed position after engine startup (wired according to Figure 2).**

- Be sure oil pressure is adequate to raise pointer past SWICHGAGE contact. (Not necessary if oil pressure SWICHGAGE is equipped with push button lockout.)
- Visually check wiring for loose connections, frayed wiring, etc. on all terminals and within switch loop circuit.
- Check 14 amp fuse connected to "B" terminal.
- Check for good ground on "G" terminal.
- Disconnect switch loop circuit from "SW1" and SW2" terminals. Place a temporary jumper between SW1 and SW2 and restart engine. If the push button stays in with engine running, the 518PH / 518APH / 518E is not the problem. This indicates either an open circuit, unwanted grounds, or too high resistance in switch loop circuit wiring between "SW1" and "SW2."
- Verify continuity by performing the following:
  1. Disconnect switch loop circuit from "SW1" and "SW2" terminals.
  2. Remove power from "B" terminal.
  3. Use an ohmmeter to check for "good continuity" (25 ohms or less) through switch loop circuit. If good continuity is indicated, proceed to Step 4.
  4. Adjust SWICHGAGE contact away from pointer. Check continuity between one end of loop circuit, "SW1" and "SW2" and ground. Good continuity (25 ohms or less) indicates an unwanted ground in loop circuit such as a terminal rotating against the mounting panel. Remove ground, restore loop circuit connections to "SW1" and "SW2."
  5. Reconnect power to "B" terminal and restart engine.
  6. Using an ohmmeter, check resistance between one end of the loop circuit to the other. Resistance should not exceed 25 ohms. If resistance is too high, check for loose connections in loop circuit. Otherwise select larger size wire for loop circuit.

**Engine fails to shutdown when contacts close on one-wire to ground SWICHGAGE controls (wired according to Figure 1).**

With engine running, jumper "SW1" to "G" terminal. If switch trips and engine shuts down, trouble could be SWICHGAGE contacts not making contact, lack of good case ground on SWICHGAGE, or broken/cut wire.

**Lack of case ground on SWICHGAGE.**

Verify that mounting bracket on the SWICHGAGE has broken through the panel paint and has made good contact with bare metal. If good contact has not been made, tighten mounting stud nuts accordingly.

**Failure of contacts on SWICHGAGE to make contact.**

Adjust contacts back and forth against the pointer to give a wiping and cleaning action on contacts. If this does not correct the problem, replace SWICHGAGE.

# Specifications

- Case: Polycarbonate
- Contact Rating: 10 A
- Coil Circuit Resistance: 339 ohms  $\pm$  10% 12 Volt  
678 ohms  $\pm$  24 Volt
- Minimum Latch Voltage: 12 Volt model: 10 VDC  
24 Volt model: 20 VDC
- Minimum Latch Current: 12 volt model: 30 mA  
24 Volt model: 30 mA
- Operating Temperature Range: -40 to 176  $\square$ F (-40 to 80  $\square$ C)

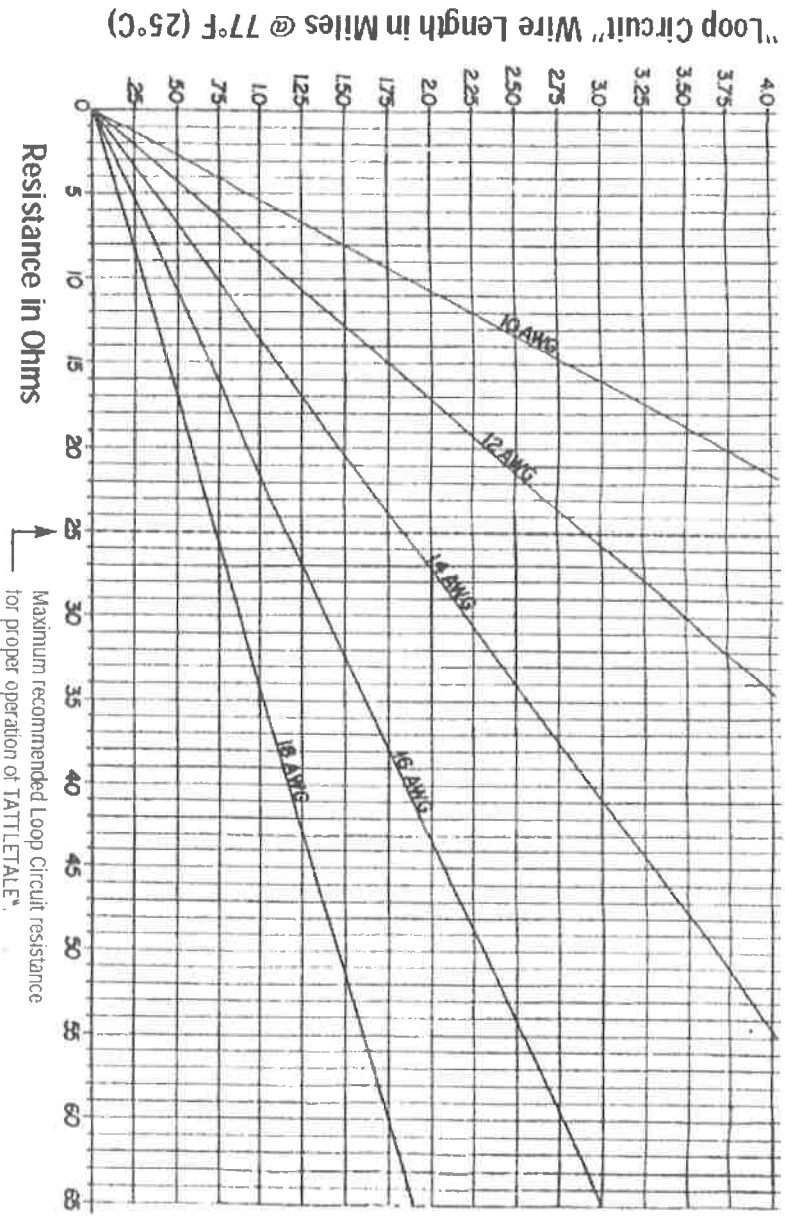

INNOVATION CONTROLS CORPORATE HEADQUARTERS  
 5311 S 122ND EAST AVENUE  
 TULSA, OK 74146  
 INNOVATION CONTROLS LTD. - UNITED KINGDOM  
 CHURCH ROAD LAVERSTOCK  
 SALISBURY SP1 1QZ UK

U.S. SALES & SUPPORT  
 MURPHY PRODUCTS  
 PHONE: 918 317 4100  
 EMAIL: SALES@INNOVATIONCONTROLS.COM  
 WWW.INNOVATIONCONTROLS.COM  
 MURPHY INDUSTRIAL PANEL DIVISION

INTERNATIONAL SALES & SUPPORT  
 EUROPE, MIDDLE EAST, AFRICA  
 PHONE: +44 1722 410055  
 EMAIL: SALES@INNOVATIONCONTROLS.EU  
 CHINA  
 PHONE: +86 21 6237 5885



Typical Wiring Diagram:

*Any chipper w/ Speed Sensing/ tach*

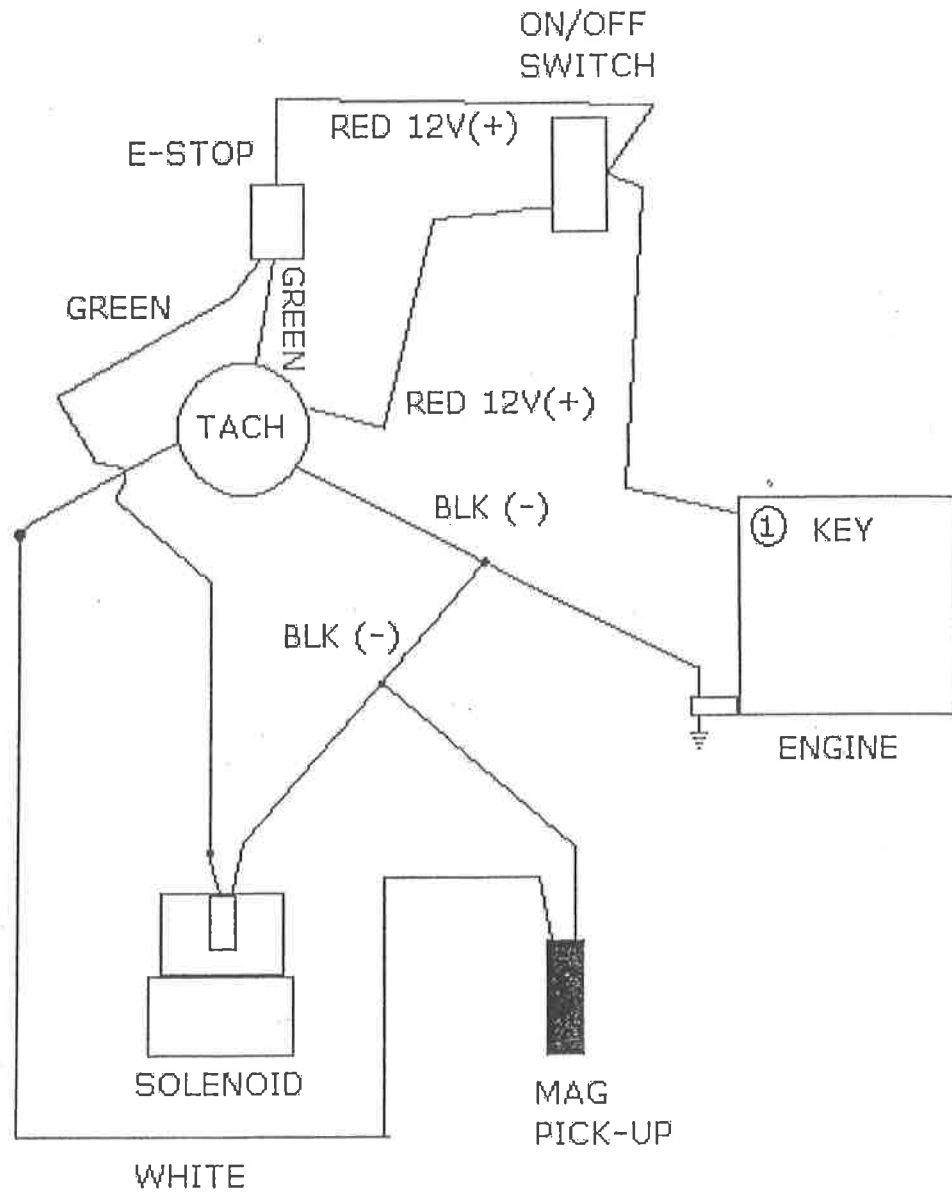

**(A) KEY SWITCH**  
**813 / 813XT – ANY ENGINE**

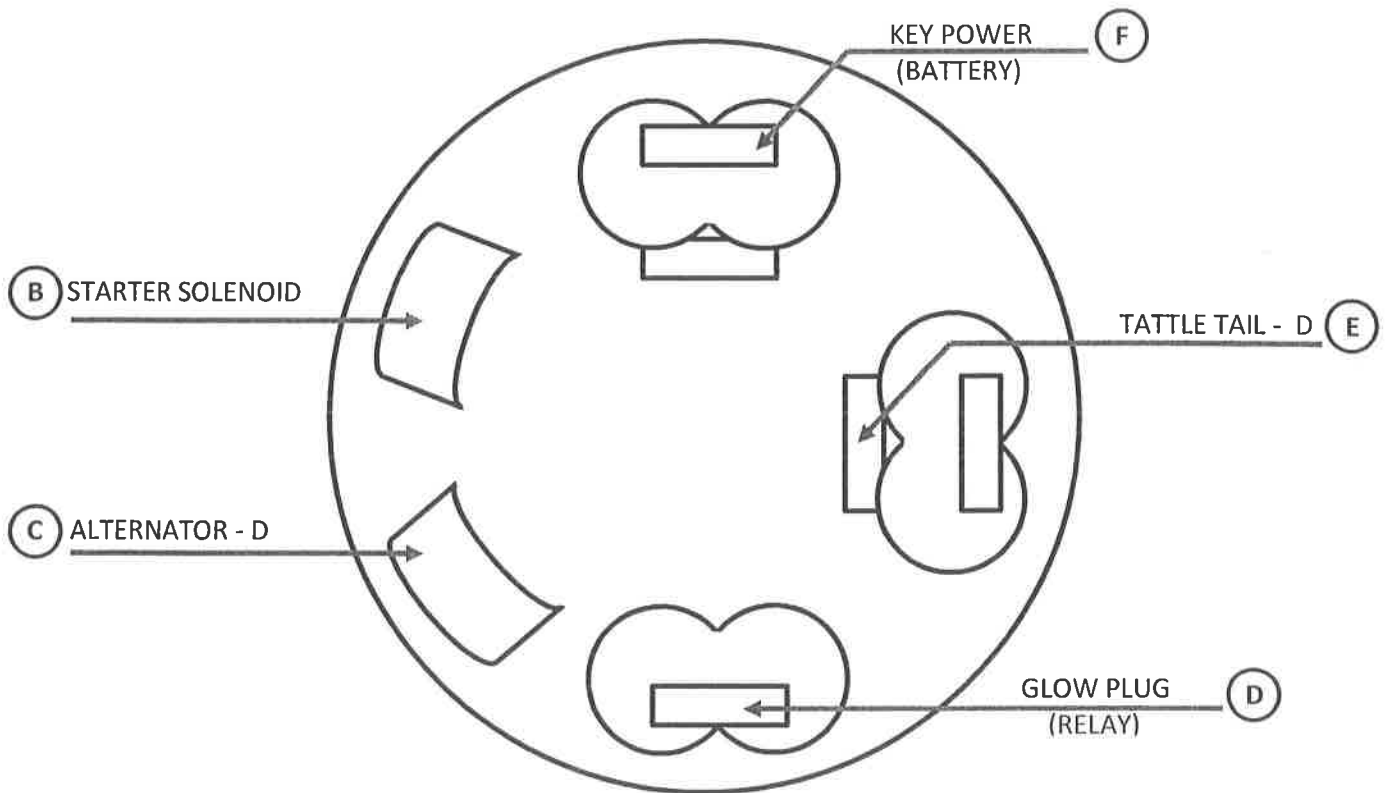

**(A) KEY POWER: (IN)**

10 AWG, PED, 20" 5/16 R/T X ¼ F/O

**(B) START:**

14 AWG, WHT, 16" #10 R/T X ¼ F/O

**(C) ALTERNATOR:**

14 AWG, YEL, 44", ¼ R/T X ¼ F/O

**(D) GLOW PLUGS:**

14 AWG, BRN, 19", #10 R/T X ¼ F/O

**(E) ACCESSORY POWER:**

FUSED LINK (PROVIDED) TIED TO SAFETY PLUG WIRING

# RELAYS & POWER SUPPLY

## (F) STARTER RELAY:

6 AWG, RED, 33", 5/16 x 5/16 RT

## (G) RELAY TO RELAY:

6 AWG, RED, 3", 5/16 x 5/16 RT

## (H) RELAY GROUNDS

10 AWG, BLK, 50", 5/16 x 3/8 RT

(I) 10 AWG, BLK, 3", 1/4 x 1/4 RT

## STARTER SOL.

(J) 10 AWG, RED, 35", 5/16 x 5/16 RT

## GLOW PLUG

(K) 10 AWG, RED, 70", 5/16 RT x DEUTSCH CNCR

## ALTERNATOR

BATTERY PWR TO ALT. BT

(L) 6 AWG, RED, 30", 5/16 RT x 1/4 RT

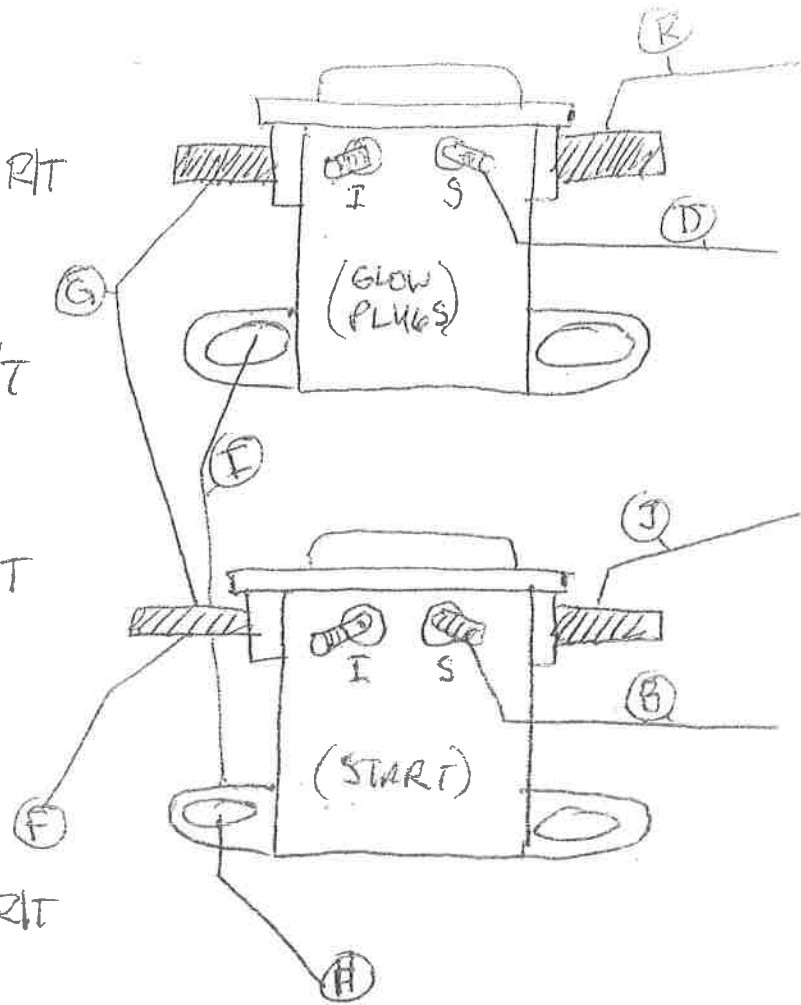

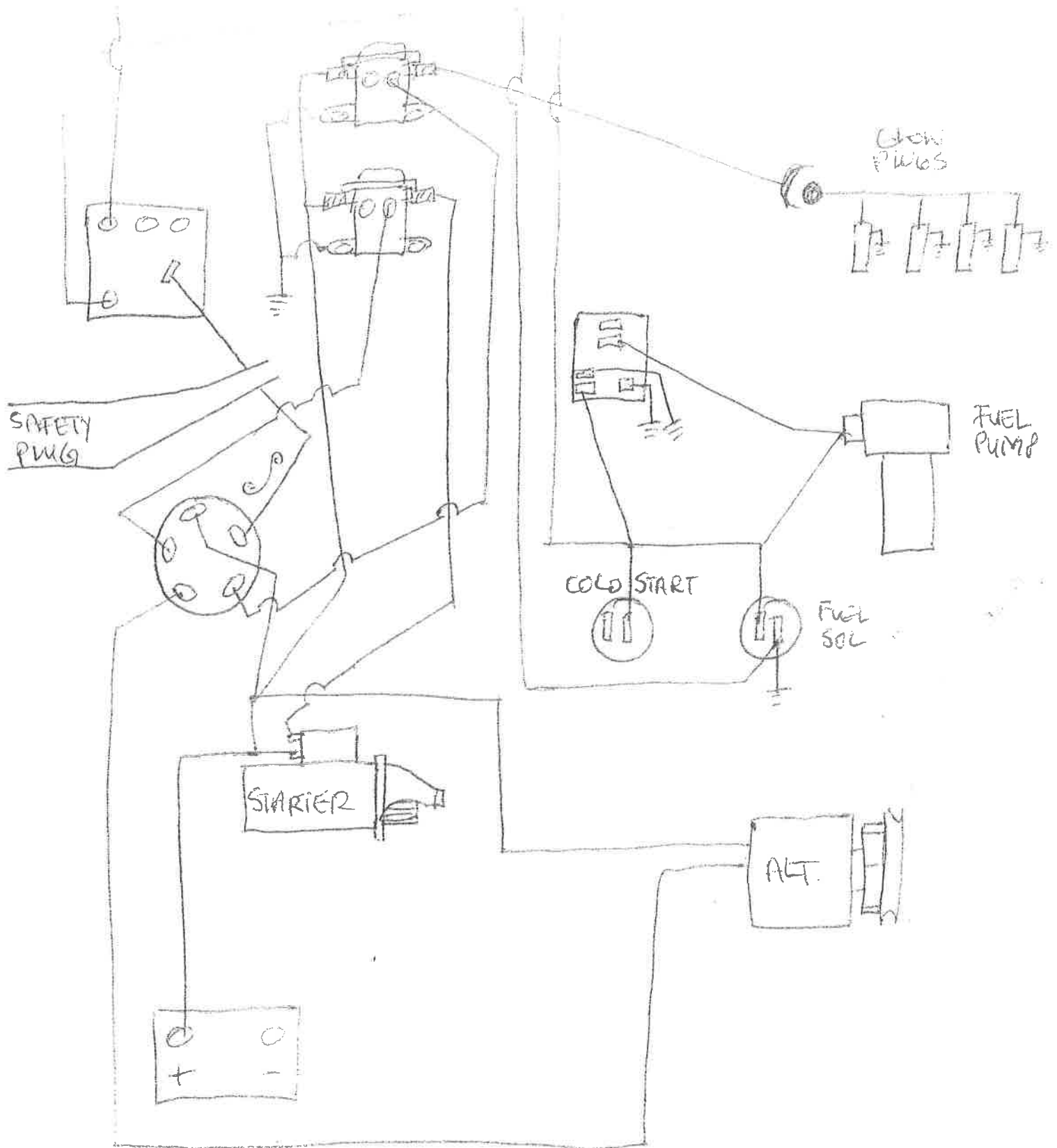

# CIT INSTRUMENT PANEL

WIRE #	DWG	COLOR	LENGTH	END <sup>1</sup>	END <sup>2</sup>
①	14	BLUE	4"	#6 RIT	#6 RIT
②	14	BLUE	7"	#6 RIT	#8 RIT
③	14	BLUE	8"	#6 RIT	#8 RIT
④	14	RED	5"	#1/4 F/O	#10 RIT
⑤	14	RED	6"	#10 RIT	#8 RIT
⑥	14	GREEN	7"	#10 RIT	#10 RIT
⑦	14	GREEN	5"	#10 RIT	#8 RIT

