



# **AIR2G2-336 OPERATOR MANUAL**

**Model 3360901 & 3360902**

**With Touch Control**

**Patent Pending**



# Introduction

A walking operator controls this machine, and it is intended to be used by professional, hired operators in commercial applications. The machine is designed primarily for decompacting large areas on well-maintained lawns in parks, golf courses, sports fields, and on commercial grounds. Using this product for purposes other than its intended use could prove dangerous to you and bystanders.

Read this information carefully to learn how to operate and maintain your product properly and to avoid injury and product damage. You are responsible for operating the product properly and safely.

Visit [www.foleyco.com](http://www.foleyco.com) for more information, including help finding a dealer, or to register your product.

Whenever you need service, use genuine Foley parts. Use of anything other than genuine Foley parts may void your warranty. For additional information, contact an authorized Foley distributor and have the model and serial numbers of your product ready.



3360901 complies with all relevant European directives; for details, please see the separate product specific Declaration of Conformity (DOC) sheet. 3360902 complies with relevant US regulations.

It is a violation of California Public Resource Code Section 4442 or 4443 to use or operate the engine on any forest-covered, brush-covered, or grass-covered land unless the engine is equipped with a spark arrester, as defined in Section 4442, maintained in effective working order or the engine is constructed, equipped, and maintained for the prevention of fire.

## WARNING

### CALIFORNIA PROPOSITION 65 WARNING

The engine exhaust from this product contains chemicals known to the State of California to cause cancer, birth defects or other reproductive harm.

Battery posts, terminals, and related accessories contain lead and lead compounds, chemicals known to the State of California to cause cancer and reproductive harm. Wash hands after handling.

Use of this product may cause exposure to chemicals known to the State of California to cause cancer, both defects, or other reproductive harm.

# Table Of Contents

Safety	2-5	Locating the Tie-Downs Points	18
Setup	6	Hauling the Machine	18
Product Overview	7-8	Maintenance	19
Specifications	9	Maintenance Safety	19
Operation	10	Recommended Maintenance Schedule	19
Before Operation Safety	10	Servicing the Air Cleaner	19
Fuel Specification	11	Removing the Filters	19
Filling the Fuel Tank	11	Installing the Filters	20
Performing Daily Maintenance	11	Checking the Engine-Oil Level	20
During Operation	12	Changing the Engine Oil and Filter	21
During Operation Safety	12	Servicing the Spark Plugs	21
Slope Safety	12	Removing the Spark Plugs	21
Using the Machine	13	Checking the Spark Plugs	21
Installing Probes	13	Fuel System Maintenance	22
Starting Engine	13	Replacing the Fuel Filter	22
Shutting Off the Engine	13	Electrical System Maintenance	23
Screen Overview	14	Electrical System Safety	23
Programs	15-16	Charging the Battery	23
E-Stop	16	Checking the Fuses	24
Setting Probe Pressure	17	Drive System Maintenance	24
Setting Inject Pressure	17	Checking the Tire Pressure	24
After Operation	18	Belt Maintenance	24
After Operation Safety	18	Adjusting the Belts	24
Cleaning The Machine	18	Inspecting the Belts	24



**Figure 2**  
**Safety-Alert Symbol**

This manual identifies potential hazards and has safety messages identified by the safety-alert symbol (Figure 2), which signals a hazard that may cause serious injury or death if you do not follow the recommended precautions.

# General Safety

This product is capable of causing personal injury. Always follow all safety instructions to avoid serious personal injury.

- Read and understand the contents of this Manual before starting the engine.
- Use your full attention while operating the machine. Do not engage in any activity that causes distractions; otherwise, injury or property damage may occur.
- Do not put your hands or feet near moving components of the machine.
- Do not operate the machine without all guards and other safety protective devices in place and working on the machine.
- Keep the machine away from bystanders while it is moving.
- Keep clear of any discharge opening. Keep bystanders and pets away from the machine.
- Keep children out of the operating area. Never allow children to operate the machine.
- Stop the machine, shut off the engine, engage the parking brake, remove the keys, and wait for all moving parts to stop before servicing, fueling, or unclogging the machine.
- Improperly using or maintaining this machine can result in injury. To reduce the potential for injury, comply with these safety instructions and always pay attention to the safety-alert symbol, which means Caution, Warning, or Danger—personal safety instruction. Failure to comply with these instructions may result in personal injury or death.

## Safety and Instructional Decals

Safety decals and instructions are easily visible to the operator and are located near any area of potential danger. Replace any decal that is damaged or missing.

Read, understand and locate all decal on this machine before operating.



WARNING do not touch hot surfaces.



This is the electrical hazard symbol. It indicates that there are **DANGEROUS HIGH VOLTAGES PRESENT** inside the enclosure of this product. TO REDUCE THE RISK OF FIRE OR ELECTRIC SHOCK, do not attempt to open the enclosure or gain access to areas where you are not instructed to do so. **REFER SERVICING TO QUALIFIED SERVICE PERSONNEL ONLY.**



WARNING - FLAMMABLE LIQUID



WARNING! Use of proper eye wear is mandatory when operating this equipment.



Sharp object in the vicinity which may cause injury. Keep hands clear of sharp edges!



Crush or shear of foot, keep away from the vicinity. Keep feet clear of area!



Entanglement Hazard. Keep clear of belt.



- **⚠ CAUTION** Use great care when operating on inclines - 15 degree maximum slope.
- **DO NOT RIDE ON EQUIPMENT.**
- **REFER TO MANUAL:** Read the user's guide carefully before operating. Follow all operating and other instructions. Remove key before service.
- Be aware of path, especially when traveling in back direction.
- Keep visitors and children at a safe distance away from the equipment.
- Do not operate equipment by turning and walking in front of machine.



No fire or open flame



No Smoking



Do not Step on

## SOUND POWER LEVEL

This machine has a guaranteed maximum sound power level of 101 dBA, which includes an Uncertainty Value (K) of 1 dBA.

Sound power level was determined according to the procedures outlined in ISO 11094 use of the CE Approved EX tech digital sound level meter.

## SOUND PRESSURE LEVEL

Taken at three (3) different sound levels at the operator's ear, which includes an Uncertainty Value (K) of 1 dBA, the levels are at idle RPM of 500 – 76.5 dBA, at 1200 RPM - 79.0 dBA, at 3000 RPM – 81.7 dBA.

Sound pressure level at 1 meter away at idle RPM 500 – 74.5 dBA, at 1200 RPM – 76.0 dBA, at 3000 RPM – 80.4 dBA. Sound pressure level was determined according to the procedures outlined in EN ISO 11201:2010-08-15.

**⚠ IMPORTANT** Ear Protection Must Be Worn!

## VIBRATION LEVEL

Hand-Arm

Measured vibration level for right hand = 5.17 m / s<sup>2</sup> at idle RPM of 500, at 1200 RPM – 6.74 m / s<sup>2</sup>, at 3000 RPM– 9.6 m / s<sup>2</sup>

Measured vibration level for left hand = 5.35 m / s<sup>2</sup> at idle RPM of 500, at 1200 RPM – 7.07 m / s<sup>2</sup>, at 3000 RPM– 10.7 m / s<sup>2</sup>

Uncertainty Value (K) = 0.3 m / s<sup>2</sup>

**⚠ IMPORTANT** Operators should not have their hands continually wrapped around the padded safety grips. After starting the actuation process, a short break of 7-10 seconds will occur at each stop at every three (3) feet (1 meter).

Measured values were determined according to the procedures outlined in EN 1032:2003+A1:2008.

ORIGINAL INSTRUCTIONS

# Setup

Loose Parts: Use the list below to verify that all parts have been shipped.

Step	Description	Qty.	Use
1	Pad Assembly	3	Screw in to install under probes- wrench provided in toolbox to tighten
2	Oil And Air Filter	2 - quarts oil, 2 air filter	Compressor oil and air filter
3	Rotate Cylinders	2	The outside air cylinders are rotated for shipping, rotate so as shown
4	Rotate Handle	1	Handle is folded down for shipping. Loosen bolts and move to desired location.
5	Tire Pressure	3	Check tire pressure. Set at rating on tire.
6	Probes	3	Install the length of probes desired. Probes are located in the toolbox.
7	Charge The Battery		

## Additional Parts:

- Ignition Key
- Battery Cutoff Key
- Operator's Manual
- Compressor Manual

**Note:** The rear of the machine is located at the Operators handle, and is the normal operator position. Left and right are in relation to the direction of travel as you walk with machine in front of you.

**Note:** To raise the center beam after uncrating the machine, start the engine. The beam should raise after the machine gets to pressure. Refer to Starting the Engine in the operations section of this manual.

**Note:** Check all hoses, fasteners and probes for tightness prior to operating the machine.

# Product Overview

Forward (operating direction)

Become familiar with all the controls before you start the engine and operate the machine.

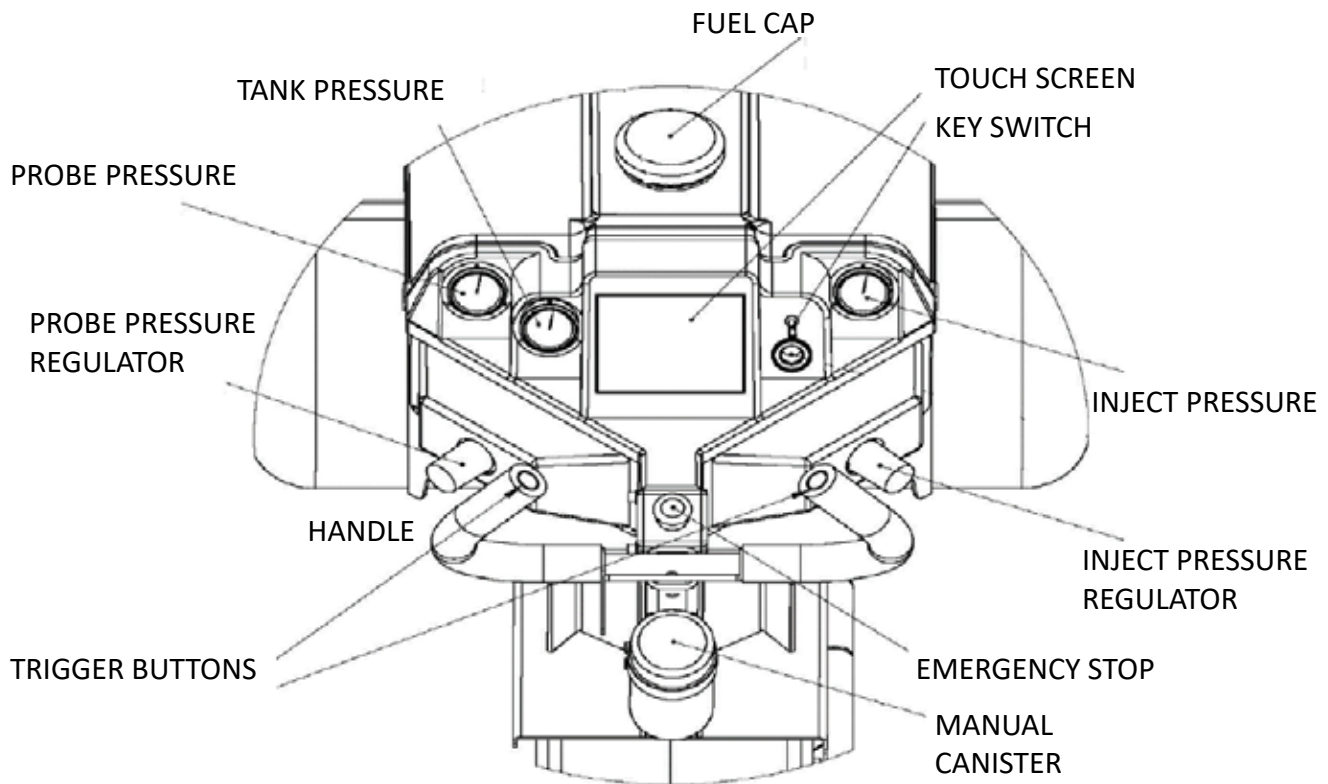
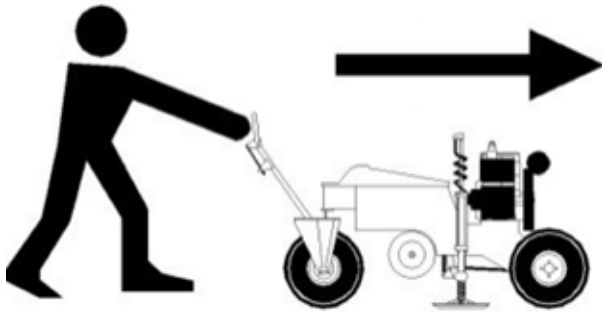

To move forward, move the handle forward. To move rearward, move the handle rearward

- The farther you move the handle the faster the machine moves.
- To stop the machine, release the handle. The handle should return to center and engage the brake. If it does not press the e-stop.

## BRAKE

The brake on the machine is engaged when the handle is in the middle of the travel. There is a brake assist that will resist the movement of the handle if the beam is not up.

The brake assist is also used as part of the operation and will be discussed later.



## TANK, PROBE AND INJECT PRESSURE

The tank pressure is the pressure in the air tank. The probe and inject pressures can be adjusted using the regulators.

## SYSTEM CUTOFF SWITCH AND KEY

This is located on the right side of the machine just above the beam. Removing this key will disconnect the battery from the control. Use this when doing service or when storing the machine for longer periods.

## IGNITION SWITCH AND KEY

Use the ignition switch to start and shut off the engine. The switch has 3 positions:

- START—rotate key clockwise to the START position to engage the starter motor.
- RUN—when the engine starts, release the key and it moves automatically to the ON position. (Turn the key to this position to activate the screen and control system)
- OFF—rotate the key counterclockwise to the OFF position to shut off the engine and control.

## THROTTLE LEVER

Use the throttle lever to control the engine speed. Moving throttle lever back increases engine speed (FAST position); moving it forward decreases engine speed (SLOW position). The engine speed regulates the speed of the compressor and maximum ground speed of the machine.

## TRIGGER SWITCH

When in the injection mode, pushing both trigger switches at the same time will start the inject cycle.

## FUEL CAP

Remove to add fuel. See adding fuel section of this manual.

## BEAM LOCK

Engage the beam lock to lock the beam in the up position.

## NEUTRAL LEVEL

Rotate to put the transmission into neutral. Note: this does not disengage the brake, to you need to move the handle off the brake position.



CUTOFF KEY



BEAM LOCK



NEUTRAL LEVER



TRANS AXLE  
RESERVOIR



# Specifications

**Note:** Specifications and design are subject to change without notice.

## Operating Temperature:

- This equipment will operate correctly in its intended ambient temperature, at a minimum between +5C and +50C.

## Relative Humidity:

- This equipment will operate correctly within an environment at 50% RH, +40C. Higher RH may be allowed at lower temperatures.
- Measures shall be taken by the Purchaser to avoid the harmful effects of occasional condensation.
- Operating in higher humidity conditions may create excess water buildup in the tank and air lines and may affect the performance of the equipment.

## Altitude:

- This equipment will operate correctly up to 1000m above mean sea level.

## Transportation and Storage:

- Equipment will withstand, or has been protected against, transportation and storage temperatures of 0C to +55C and short periods up to +60C.

Width (Extended)	88in (224cm)
Width (Retracted)	63in (160cm)
Wheel base	60in (152cm)
Probe Distance	36in (91cm) x2
Length	95in (241cm)
Height, Handle	52in (104cm)
Ground Clearance	2.5in (6cm)
Forward Speed	0 to 6 kph (0 to 4mph)
Reverse Speed	0 to 3 kph (0 to 2 mph)
Net weight	940lb (427kg)

Probe Lengths	Part Number	
6in (15cm)	PR-14-006	(Not included)
7in (18cm)	PR-14-007	(Included)
9in (23cm)	PR-14-009	(Included)
12in (31cm)	PR-14-012	(Included)

Probe Tip	PR-14-002	Replaceable tip for any size above
Probe Spring	PR-14-004	Spring inside probe

# Operation

**Note:** Determine the left and right sides of the machine from the normal operating position.

## Before Operation Before Operation Safety

### General Safety

- Never allow children or untrained people to operate or service the machine. Local regulations may restrict the age of the operator. The owner is responsible for training all operators and mechanics.
- Become familiar with the safe operation of the equipment, operator controls, and safety signs.
- Know how to stop the machine and shut off the engine quickly.
- Check that operator-presence controls, safety switches, and shields are attached and functioning properly. Do not operate the machine unless they are functioning properly.
- Before operating, always inspect the machine to ensure that the probes are in good working condition. Replace worn or damaged probes.
- Inspect the area where you plan to use the machine and remove all objects that the machine could strike.
- Locate and mark all electrical or communication lines, irrigation components, and other obstructions in the area to be decompacted. Remove the hazards, if possible, or plan how to avoid them.
- Park the machine on a level surface; engage the brake; shut off the engine; remove the key; and wait for all movement to stop before leaving the machine.

### Fuel Safety

- Use extreme care in handling fuel. It is flammable, and its vapors are explosive.
- Extinguish all cigarettes, cigars, pipes, and other sources of ignition.
- Do not remove the fuel cap or fill the fuel tank while the engine is running or hot.
- Do not add or drain the fuel in an enclosed space.
- Do not store the machine or fuel container where there is an open flame, spark, or pilot light, such as on a water heater or other appliance.
- If you spill fuel, do not attempt to start the engine; avoid creating any source of ignition until the fuel vapors have dissipated.

# Adding Fuel

## Fuel Specification

- For best results, use only clean, fresh (less than 30 days old), unleaded gasoline with an octane rating of 87 or higher ((R+M)/2 rating method).
- Ethanol: Gasoline with up to 10% ethanol (gasohol) or 15% MTBE (methyl tertiary butyl ether) by volume is acceptable. Ethanol and MTBE are not the same. Do not use gasoline with 15% ethanol (E15) by volume. Never use gasoline that contains more than 10% ethanol by volume, such as E15 (contains 15% ethanol), E20 (contains 20% ethanol), or E85 (contains up to 85% ethanol). Using unapproved gasoline may cause performance problems and/or engine damage which may not be covered under warranty.
- Do not use fuel containing methanol.
- Do not store fuel either in the fuel tank or fuel containers over the winter unless you use a fuel stabilizer.
- Do not add oil to fuel.

**⚠ IMPORTANT** Do not use fuel additives other than a fuel stabilizer/conditioner. Do not use fuel stabilizers with an alcohol base such as ethanol, methanol, or isopropanol.

**⚠ IMPORTANT** Do not use methanol, gasoline containing methanol, or gasohol containing more than 10% ethanol because the fuel system could be damaged. Do not mix oil with fuel.

## Filling the Fuel Tank

Fuel tank capacity: 5 US gallons (18.5 L)

1. Park the machine on a level surface, shut off the engine, engage the parking brake, and remove the key.
2. Clean around the fuel-tank cap and remove it.
3. Add fuel to the fuel tank, until the level is 6 mm to 13 mm (1/4 to 1/2 inch) below the bottom of the filler neck.

**⚠ IMPORTANT** This space in the tank allows fuel to expand. Do not fill the fuel tank completely full.

4. Install the fuel-tank cap securely.
5. Wipe up any spilled fuel.

## Performing Daily Maintenance

Before starting the machine each day, perform the following daily-check procedures:

- Checking the Engine-Oil Level
- Checking the compressor oil level.
- Checking the level in the trans axle oil reservoir.
- Check tire pressure before and after each use.
- Check probes before and after each use for excessive wear.
- After all air has been released, remove each cylinder and move the rod up and down, 2-3 times, to expel any moisture build-up in the cylinder. Use the brush (provided in the toolbox on the machine) to clean out the cylinder mount tubes. Re-mount the cylinders to the base.
- After each use, it is important to store the AIR2G2®-336 without having air pressure in the system.
- Pressure can be released in 3 different ways: 1) Press and release #8; 2) Open ball valve on right side of air tank, or 3) Open the water separator and drain water and air.

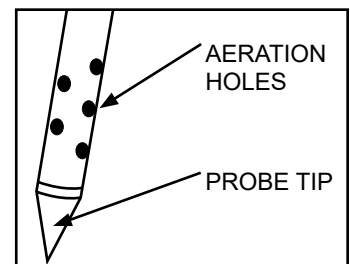

# During Operation

## During Operation Safety

- The owner/operator can prevent and is responsible for accidents that may cause personal injury or property damage.
- Wear appropriate clothing, including eye protection; long pants; substantial, slip-resistant footwear; and hearing protection. Tie back long hair, secure loose clothing, and do not wear loose jewelry.
- Do not operate the machine when tired, ill, or under the influence of alcohol or drugs.
- Never carry passengers on the machine and keep bystanders and pets away from the machine during operation.
- Operate the machine only in good visibility to avoid holes or hidden hazards.
- Keep your hands and feet away from the probes and beam.
- Look behind and down before backing up to be sure of a clear path.
- Stop the machine, shut off the engine, remove the key, wait for all moving parts to stop, and inspect the probes after striking an object or if there is an abnormal vibration in the machine. Make all necessary repairs before resuming operation.
- Always maintain proper tire pressure.
- Reduce traction speed on rough surfaces.

## Slope Safety

- Slopes are a major factor related to loss of control and rollover accidents, which can result in severe injury or death. You are responsible for safe slope operation. Operating the machine on any slope requires extra caution. Do not operate on a slope of more than 15 degrees.
- Evaluate the site conditions to determine if the slope is safe for machine operation including surveying the site. Always use common sense and good judgment when performing this survey.
- Review the conditions to determine whether you can operate the machine in the conditions on that day and at that site. Changes in the terrain can result in a change in slope operation for the machine.
- Avoid starting, stopping, or turning the machine on slopes. Avoid making sudden changes in speed or direction. Make turns slowly and gradually.
- Do not operate a machine under any conditions where traction, steering, or stability is in question.
- Remove or mark obstructions such as ditches, holes, ruts, bumps, rocks, or other hidden hazards.
- Tall grass can hide obstructions. Uneven terrain could overturn the machine.
- Be aware that operating the machine on wet grass, across slopes, or downhill may cause the machine to lose traction. Loss of traction to the drive wheels may result in sliding and a loss of braking and steering.
- Use extreme caution when operating the machine near drop offs, ditches, embankments, water hazards, bunkers or other hazards. The machine could suddenly roll over if a wheel goes over the edge or the edge caves in. Establish a safety area between the machine and any hazard.

# Installing Probes

1. Make sure machine is on a flat surface, brake is engaged and key is removed.

**⚠ IMPORTANT** Never change probes with machine on.

2. Select the length of probe. Check the condition of the probe, do not use bent or worn probes.
3. Loosen the 4 nuts on the bottom of the air cylinder (use the 7/16 wrench in the toolbox).
4. Rotate the air cylinder Clockwise and lift up to remove.
5. Manually move the cylinder rod up and down 2 or 3 items to push any excess moisture from the cylinder before installing probes.
6. Removed the cap from the probe, be careful to not let the spring that is in the probe fall out.
7. Screw the probe into the end of the cylinder and tighten. (Wrench is in the toolbox).
8. Place the air cylinder on the machine and rotate clockwise.
9. Tighten the 4 nuts on the air cylinder to just tight, do not over tighten.

Tighten these in a star pattern: #1, #2 straight across, #3 (to the left of #2), #4 (across from #3).

**⚠ IMPORTANT** Torque nuts on air cylinder to a maximum of 5 ft-lbs. (6Nm).  
Over tightening will damage threads on Air cylinder.

# Using the Machine

1. Start the engine.
2. Look in the direction of your planned path to ensure that it is clear.
3. Move the forward to drive the machine forward. Walk in a forward direction while operating the machine, do not walk and face rearward when operating the machine.
4. To stop the machine, release the traction bail.
5. To start decompaction use the touch screen.

# Starting the Engine

1. Make sure the handle bar is in the center position so the brake is on. The machine will not start if the handle is not in the center position (check the indicator light by the right front tire if the engine will not start).
2. Move the throttle lever to the Middle position before starting a cold engine.
3. Turn the ignition key to start. When the engine starts, release the key.

**⚠ IMPORTANT** Do not engage the starter for more than 10 seconds at a time. If the engine fails to start, allow a 30-second cool down period between attempts. Failure to follow these instructions can burn out the starter motor.

4. After the engine starts move the throttle lever to desired setting.

# Shutting Off the Engine

1. Move the throttle lever to the SLOW position.
2. Let the engine idle for 60 seconds.
3. Turn the ignition key to the OFF position and remove the key.
4. Turn the System cutoff key off and remove the key before transporting or storing the machine.

**⚠ CAUTION** Children or bystanders may be injured if they move or attempt to operate the machine while it is unattended. Always remove the ignition key and engage the brake when leaving the machine unattended, even if just for a few minutes.

# Screen Overview

When the key is turned to run, the screen will turn on.

The MAINTENANCE screen will appear for a couple of seconds and then change to the Main screen.

The Main screen will display the speed the machine is traveling at in MPH.

To access the Service screen press the wrench.

Press the down arrow to go the INJECT PROGRAM screen.

Note: the icon in the upper right corner will indicate if the brake assist is on. The machine will not move when the brake is on. Attempting to force the handlebar may damage the drive cable.

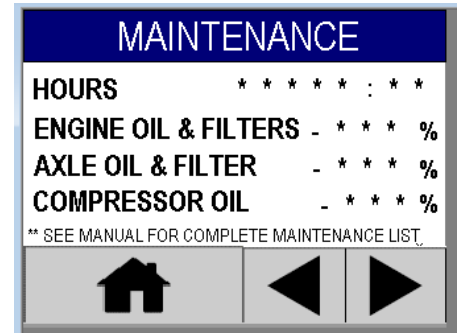

INDICATES BRAKE ASSIST IS ON

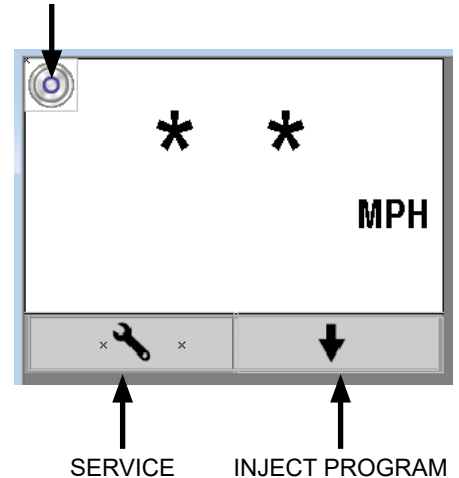

## SERVICE SCREEN:

This screen allows you to turn the Trainer mode on or off. Turning the trainer mode off eliminates certain reminder screens

The Brake assist can be turned on or off in all areas or just when doing the inject cycles. Pressing The BRAKE ASSIST will turn on/off the automated braking when running an inject program.

Pressing the BRAKE button will turn the brake assist off in all area.

The HOME button brings you back to the Main screen, and the ARROW will bring you to the Maintenance Screen.

From the MAINTENANCE screen you can Access the RESETS for the different Oil and Filter indicators.

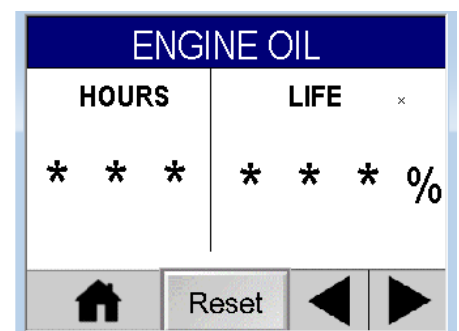

# Screen Overview

## Injection Program

Pressing the Inject button will bring you to the screen showing you the current inject setting.

To change these setting press the CHANGE button (see next page for details)

If the settings look correct then press the arrow.

The SET PROBE PRESSURE and SET INJECT PRESSURE screens are there as a reminder to adjust the pressure before starting. See Probe and Inject pressure section for setting the pressure.

**NOTE:** The screens will not appear if the trainer mode is turned off.

Once the program has started you will see the INJECT screen. The Brake will be activated once the program is started.

**⚠ WARNING** Before starting the inject process be sure there are no underground hazards. All electrical or communication lines, gas lines, irrigation components, and other obstructions in the area need to be identified and avoided. Contacting ungrounded power lines, gas lines or other hazards could lead to injury or death.

With the machine STOPPED press both Trigger Switches on the Handle to start the Inject cycle.

The Beam will lower and lock, the Probes will extend into the ground and the Air inject will start.

After the Injection is done the Probes will retract and the Beam will return to the up position. You can then move forward. If the Brake assist is on, the machine will stop at the predetermined distance. If the Brake assist is off then the distance traveled will be displayed on the left side of the screen.

**⚠ IMPORTANT** Do not attempt to move the machine when the probes are in the ground. Damage to the machine, probes or ground will occur.

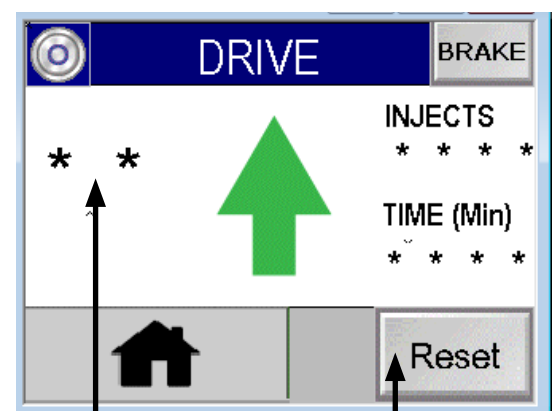
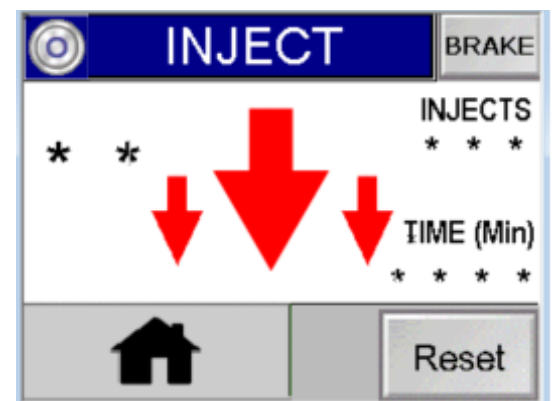
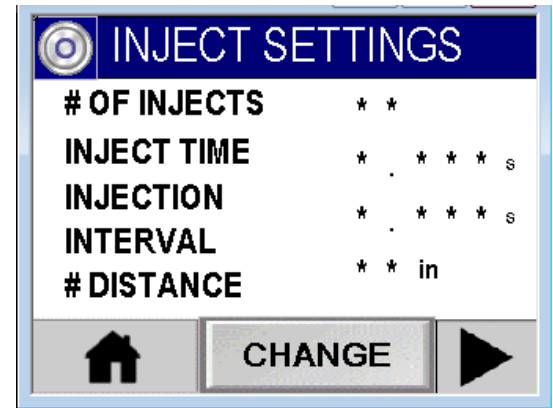

DISTANCE TRAVELED IF BRAKE IS OFF

RESET INJECT COUNT AND TIME



# Screen Overview - Continued

Pressing the CHANGE button on the Inject Settings screen bring you to the Setup Screen.

There are 3 programs to select from depending on your needs.

LIGHT is for areas that are regularly decompacted.

STANDARD can be used for most applications.

HEAVY should be used if the soil has never been decompacted or has compaction issues.

Press the CUSTOM button to select custom settings to use. You will be able to select the number of injections (air blasts when the probes in the ground)

The Injection time is the length of time for each blast of air.

And the Injection interval is the time between each blast of air.

Use the arrows in the left side of the screen to increase or decrease to the desired value.

If the Emergency Stop button is pressed the screen will indicate that this has been pressed. To reset the stop twist the button and it will return to the up position.

## **⚠ CAUTION**

Pressing the Emergency Stop will stop the engine and turn off the valves that control the beam and air cylinders. There will still be air in the tank and power in the control that would have the potential to cause injury or harm. Use the Cutoff Switch on the side to remove power and open the tank drain or filter drain to release the air pressure.

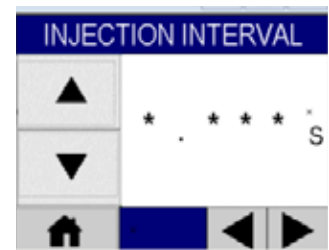
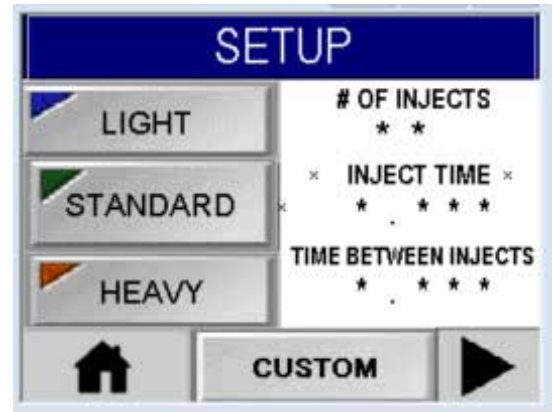

# Setting the Probe Pressure

Use the PROBE PRESSURE REGULATOR to set the Probe pressure. This adjusts the pressure for the beam and the force that the probes will use to push into the ground. To adjust pull out on the knob and rotate clockwise to increase the pressure and counter clockwise to decrease the pressure. The selected pressure will display on the Probe pressure gauge as long as the system pressure is above the selected pressure. Press the knob in to lock it in place.

Note: The probe pressure will need to be set to around 50PSI to get the beam to lock.

To select the proper pressure, start with the pressure to around 30-50 PSI. With the Machine on the Inject screen, press the 2 trigger switches on the handle. The beam should lower and pivot arms should lock, if the pivot arms do not lock then the pressure will need to be increased. After the beam goes down the probes should extend. If they do not extend fully into the ground increase the Probe pressure.

If you wish to try and get multilayer breakup in the solid then you will need to adjust the pressure until the probe stop at this compacted layer. You may need to adjust this multiple times depending on where the compaction layer is. Some soils do not have a compaction layer, in that case you can adjust the pressure until the probe fully extends.

The maximum pressure that you can set the probes to is 120 PSI

## **⚠ CAUTION**

**If the 12 in probes are installed and the ground is severely compacted adjusting the pressure above 80 psi could result in the machine being lifted. This can be cause the machine to roll if it is on a slope or hill.**

# Setting the Inject Pressure

Use the INJECT PRESSURE REGULATOR to set the Inject pressure, which is the pressure of the air that is released underground. To adjust pull out on the knob and rotate clockwise to increase the pressure and counter clockwise to decrease the pressure. The selected pressure will display on the Probe pressure gauge as long as the system pressure is above the selected pressure. Press the knob in to lock it in place.

It is recommended to start with a pressure between 30 and 50 psi and adjust to get the desired effect. Depending on the desired decompaction you may or may not see the ground move when the injections occur. If there is too much movement of the ground or if the turf is being damaged then reduce the pressure.

It is recommended to start low and increase after testing. Too high a pressures could result in turf damage or blowouts.

# After Operation

## After Operation Safety

- Park the machine on a level surface; and make sure the brake is engaged; shut off the engine; remove the key; and wait for all movement to stop before leaving the machine.
- Keep all parts of the machine in good working condition and all hardware tightened.
- Replace all worn, damaged, or missing components or decals.

## Cleaning the Machine

Service Interval: Before each use or daily

1. Thoroughly wash the machine. Use a brush to remove caked-on material.  
Note: Use a garden hose without a nozzle to avoid forcing water past the seals and contaminating bearing grease.
2. Use mild detergent to clean the covers.
3. Inspect the machine for damage, oil leaks, and component and probe wear.
4. Remove, clean, and oil the cylinder shafts and probes.  
Important: Secure the beam with the lock levers before you store the machine for more than a couple of days.

## Locating the Tie-Down Points

There are tie downs located at the front and rear of the machine.

Note: Use properly-rated straps to tie down the machine.

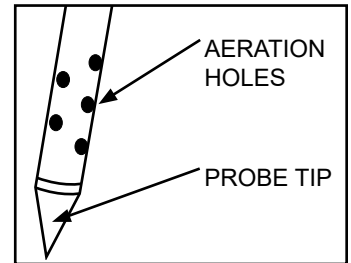

## Hauling the Machine

**⚠ WARNING** Driving the machine on street or roadway without turn signals, lights, reflective markings, or a slow-moving vehicle emblem is dangerous and can lead to accidents causing personal injury. Do not operate the machine on a public street or roadway.

Important: Use full-width ramps for loading the machine onto a trailer or truck.

1. Load the machine onto the trailer or truck (Engine forward—preferred).
2. Ensure the brake is engaged, shut off the engine, and remove the keys.
3. Install the cylinder lock clamps
4. Lock beam in the up position.
5. At the tie-down points, bind the machine to the trailer or truck with cables, chains, or straps.

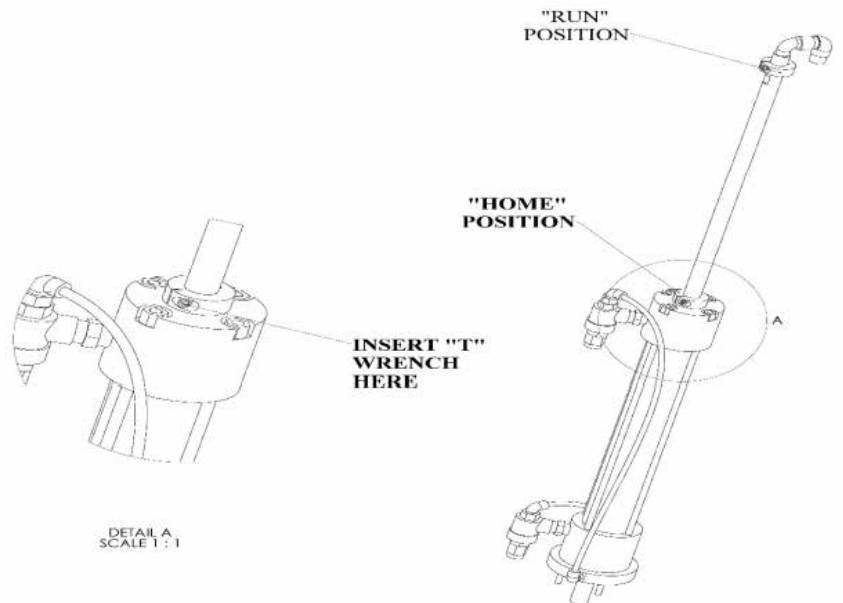

# Maintenance

**Note:** Determine the left and right sides of the machine from the normal operating position.

## Maintenance Safety

**▲ CAUTION** If you leave the key in the ignition switch, someone could accidentally start the engine and seriously injure you or other bystanders. Shut off the engine, remove the key, turn off the cutoff, remove the cutoff key and secure the beam with the beam locks before servicing or adjusting to the machine.

- Always shut off the machine, remove the keys wait for all moving parts to stop, and allow the machine to cool before adjusting, servicing, cleaning, or storing it.
- Perform only those maintenance instructions described in this manual. If major repairs are ever needed or assistance is desired, contact an authorized Foley distributor.
- Ensure that the machine is in safe operating condition by keeping nuts, bolts, and screws tight.
- If possible, do not perform maintenance while the engine is running. Keep away from moving parts.
- Carefully release pressure from components with stored energy.
- Check the probe mounting bolts daily to be sure that they are tightened to specification.
- Ensure that all guards are installed, and the hood is secured shut after maintaining or adjusting the machine.
- Use only Foley Company approved parts, warranty will be VOID if genuine approved parts are not used.

## Maintenance Schedule

- Service Kohler engine after first 50 hours and every 100 hours of use thereafter. (10W-30 Oil)
- Service Ingersoll Rand Air Compressor every 100 hours. (Ingersoll-Rand All Season Select Oil)
- Service Hydro-Gear Trans axle after first 50 hours and then every 200 hours thereafter. (20W-50 Oil)
- Belts should be re-tensioned after ½ hour to 24 hours of first full use. Should be checked before every use.
- Check for air leaks periodically. (Use soapy water to aid in finding any leaks)
- Check all nuts and bolts on moving parts of machine to ensure they are properly tight.

## Servicing the Air Cleaner

There are 3 air cleaners that will need to be maintained:

- Engine - Has a paper filter with a foam pre-cleaner.
- Compressor has a paper filter.
- Air filter has a solid filter.

Service Interval: Every 25 hours—Clean the foam air filter element (engine only) and check the paper element for damage (both engine and compressor).

Every 100 hours—Replace the paper air filter element.

## Removing the Filters

1. Park the machine on a level surface, shut off the engine, verify the brake is engaged, and remove the keys.
2. Clean around the air cleaner to prevent dirt from getting into the engine/Compressor and causing damage.
3. Unscrew the knob and remove the air-cleaner cover.

## Installing the Filters

**⚠ IMPORTANT** To prevent engine damage, always operate the engine with the complete foam and paper air cleaner assembly installed.

1. Carefully slide the foam pre-filter onto the paper filter.
2. Place the air cleaner assembly onto the air cleaner base.
3. Install the cover and secure it with the cover nut.
4. Install the air cleaner cover and secure with the knob.

**⚠ IMPORTANT** To prevent compressor damage, always operate the Compressor with the complete paper air cleaner assembly installed.

1. Place the air cleaner assembly onto the air cleaner base.
2. Install the air cleaner cover and secure with the knob.

## Air filter

1. Place the air cleaner assembly onto the air filter.
2. Install the air filter cover and secure by rotating to lock into place.

## Checking the Engine-Oil Level

Service Interval: Before each use or daily (Check the oil when the engine is cold.)

The engine is shipped with oil in the crankcase; however, check the oil level before and after the engine is first started.

Use high-quality engine oil as described in Engine Oil Specification.

**⚠ IMPORTANT** Do not overfill the crankcase with oil because this may cause engine damage. Do not run the engine with oil below the low mark because the engine may be damaged as a result.

**Note:** The best time to check the engine oil is when the engine is cool before it has been started for the day. If it has already been run, allow the oil to drain back down to the sump for at least 10 minutes before checking.

1. Park the machine on a level surface, shut off the engine, verify brake is engaged, and remove the key.
2. Clean around the oil dipstick so dirt cannot fall into the filler hole and damage the engine.
3. Remove the dipstick, wipe it clean, and install until it is fully seated.
4. Remove the dipstick and check the oil level. The oil level should be between the “F” full and “L” low marks on the dipstick.
5. If the oil level is below the “L” low mark, remove the filler tube cap and add the specified oil until the level reaches the “F” full mark on the dipstick.
6. Install the oil fill cap and dipstick.

## Changing the Engine Oil and Filter

Service Interval: After the first 50 hours

Every 100 hours—Change the engine oil and filter.

Crankcase capacity: approximately 1.9 L (2.0 US qt) with the filter.

1. Start the engine and let it run for 5 minutes. This warms the oil so that it drains better.
2. Park the machine so that the drain side is slightly lower than the opposite side to ensure that the oil drains completely, shut off the engine, verify the brake is engaged, and remove the key.
3. Place a pan below the oil drain. Remove the oil drain plug to allow oil to drain.
4. When the oil has drained completely, replace the plug.  
Note: Dispose of the used oil at a certified recycling center.
5. Place a shallow pan or rag under the filter to catch oil.
6. Remove the old filter and wipe the surface of the filter adapter gasket.
7. Pour new oil of the proper type through the center hole of the filter. Stop pouring when the oil reaches the bottom of the threads.
8. Allow a minute or 2 for the oil to be absorbed by filter material, then pour off the excess oil.
9. Apply a thin coat of new oil to the rubber gasket on the replacement filter.
10. Install the replacement oil filter to the filter adapter. Turn the oil filter clockwise until the rubber gasket contacts the filter adapter, then tighten the filter an additional 1/2 turn.
11. Remove the oil fill cap and slowly pour approximately 80% of the specified amount of oil in through the valve cover.
12. Check the oil level; refer to Checking the Engine-Oil Level.
13. Slowly add additional oil to bring the level to the F (full) mark on the dipstick.
14. Install the oil fill cap and dipstick.

## Servicing the Spark Plugs

Service Interval: Every 200 hours—Check the spark plugs.

Ensure that the air gap between the center and side electrodes is correct before installing each spark plug.

Use a spark-plug wrench for removing and installing the spark plugs and a gapping tool/feeler gauge to check and adjust the air gap. Install new spark plugs if necessary.

## Removing the Spark Plugs

1. Shut off the engine, verify that the brake is engaged, and remove the keys.
2. Pull the wires off the spark plugs
3. Clean around the spark plugs.
4. Remove both spark plugs and metal gaskets.

## Checking the Spark Plugs

1. Look at the center of both spark plugs. If you see light brown or gray on the insulator, the engine is operating properly. A black coating on the insulator usually means the air cleaner is dirty.
2. Check the gap between the center and side electrodes.
3. Bend the side electrode if the gap is not correct.

# Fuel System Maintenance

**⚠ DANGER** Under certain conditions, fuel and fuel vapors are highly flammable and explosive. A fire or explosion from fuel can burn you and others and can cause property damage.

- Fill the fuel tank outdoors, in an open area, when the engine is off and is cold. Wipe up any fuel that spills.
- Do not fill the fuel tank completely full. Add fuel to the fuel tank until the level is 25 mm (1 inch) below the top of the tank, not the filler neck. This empty space in the tank allows the fuel to expand.
- Never smoke when handling fuel, and stay away from an open flame or where a spark may ignite fuel fumes.
- Store fuel in a clean, safety-approved container and keep the cap in place.

## Replacing the Fuel Filter

Service Interval: Every 100 hours/Yearly (whichever comes first)

Important: Never install a dirty filter if it is removed from the fuel line.

1. Allow the machine to cool down.
2. Disconnect the Fuel tank - Quick connect.
3. Squeeze the ends of the hose clamps together and slide them away from the filter.
4. Remove the filter from the fuel lines
5. Install a new filter and move the hose clamps close to the filter.
6. Wipe up any spilled fuel.
7. Reconnect the Fuel tank.



# Electrical System Maintenance

## Electrical System Safety

- Disconnect the battery before repairing the machine. Turn off the cutoff Key and remove. Then Disconnect the negative terminal first and the positive last. Connect the positive terminal first and the negative last.
- Charge the battery in an open, well-ventilated area, away from sparks and flames. Unplug the charger before connecting or disconnecting the battery.
- Wear protective clothing and use insulated tools.

### **⚠ WARNING**

## California

Proposition 65 Warning Battery posts, terminals, and related accessories contain lead and lead compounds, chemicals known to the State of California to cause cancer and reproductive harm. Wash hands after handling.

## Charging the Battery

**⚠ WARNING** Charging the battery produces gases that can explode.

Never smoke near the battery and keep sparks and flames away from the battery.

**⚠ WARNING** Battery terminals or metal tools could short against metal components or machine, causing sparks. Sparks can cause the battery gases to explode, resulting in personal injury.

- When removing or installing the battery, do not allow the battery terminals to touch any metal parts of the machine.
- Do not allow metal tools to short between the battery terminals and any metal parts.

**⚠** **Incorrect battery cable routing could damage the machine and cables, causing sparks. Sparks can cause the battery gases to explode, resulting in personal injury.**

- Always disconnect the negative (black) battery cable before disconnecting the positive (red) cable.
  - Always connect the positive (red) battery cable before connecting the negative (black) cable.
1. Remove the battery from the battery tray:
    - A. Remove the battery hold down and hold down rods that secure the battery to the tray
    - B. Remove the bolt and nut that secure the negative battery cable (black) to the negative (–) terminal and disconnect the negative cable.
    - C. Remove the bolt and nut that secure the positive battery cable (red) to the positive (+) battery terminal and disconnect the positive cable.
  2. Clean the top of the battery.
  3. Connect a 3 to 4 A battery charger to the battery posts. Charge the battery at a rate of 3 to 4 A for 4 to 8 hours.
  4. When the battery is charged, disconnect the charger from the electrical outlet and battery posts.
  5. Insert the battery into the tray.
  6. Connect the positive battery cable (red) to the positive (+) battery terminal with the previously removed bolt and nut; slide the rubber boot over the positive terminal to prevent a possible short from occurring.
  7. Connect the negative battery cable (black) to the negative (–) terminal with the previously removed bolt and nut.
  8. Reinstall the hold down bar and rods to secure the battery.

## Checking the Fuses

The electrical system is protected by fuses. It requires no maintenance; however, if a fuse blows, check the component/circuit for a malfunction or short.

1. To replace fuses, pull out on the fuse to remove it.
2. Install a new fuse.

## Drive System Maintenance

### Checking the Tire Pressure

Service Interval: Every 50 hours/Monthly (whichever comes first)

Park the machine on a level surface, shut off the engine, verify the brake is engaged, and remove the key.

Check to ensure that the air pressure is at the level rated on the tire. Check the tires when they are cold to get the most accurate pressure reading.

## Belt Maintenance

### Adjusting the Belts

Service Interval: After the first 8 hours

1. Park the machine on a level surface, shut off the engine, verify the brake is engaged, and remove the key.
2. Remove screws that hold on the belt cover, and remove the belt cover.
3. Loosen the bolts that hold on the tensioner if the belt tension needs to be adjusted.  
**Note:** Do not over tension the belt as it will damage it.
4. After inspecting and adjusting the tension secure the belt idler bolts.
5. Install the belt cover with the screws previously removed.

### Inspecting the Belts

Service Interval: Yearly

The drive belts on the machine is durable. However, the normal exposure to UV radiation, ozone, or incidental exposure to chemicals can deteriorate the rubber over time and lead to premature wear or material loss (i.e., chunking).

Inspect the belts yearly for signs of wear, excessive cushion cracks, or large embedded debris. Replace them when needed. Components may result.

# Customer Support



## Contact Customer Support

Foley Company

1750 Ryden RD

Prescott, WI 54021

Call: 904-507-8900

Email: [air2g2support@foleyco.com](mailto:air2g2support@foleyco.com)

Facebook: [facebook.com/FoleyCompany](https://facebook.com/FoleyCompany)

Twitter: [@Foley\\_Company](https://twitter.com/Foley_Company)

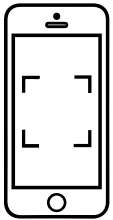

Scan on your  
mobile device  
to contact  
customer  
support

